

# TEVO WIRELESS

INSTALLATION & USER MANUAL

# TEVO WIRELESS

Enabling complete home heating control with intelligent adaptations for underfloor heating, radiator circuits and hot water timer control.

The Tio TEVO wireless thermostat is only compatible with the Tio wireless wiring centre.

A Tio multifunctional gateway is required to access the in-app smart features on this thermostat.



Wireless wiring centre - TIOEVO0003



Gateway - TIOEVO0004



# YOUR SMART LIFE JOURNEY BEGINS NOW

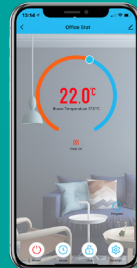

You can operate your system wirelessly using the SMARTLIFE app.

# SYSTEM OVERVIEW

Your TEVO thermostat requires 2 AA batteries (not included).



Your wiring centre needs to be wired manually.



















Your wireless gateway comes with a USB power cable.

# CONTENTS

OVERVIEW	5
THERMOSTAT CONFIGURATION	9
WIRING CENTRE PAIRING	18
GATEWAY PAIRING	20
APP CONFIGURATION	27
IMPORTANT NOTES	32
VOICE CONTROL	34

# ICON OVERVIEW

-  RF network signal  
Flashing - Pairing  
Stable - Connected
-  WiFi - connected to gateway
-  Actual room temperature
-  Desired sensor temperature
-  Screen lock
-  Manually (clock and hand) or in permanent manual mode (hand only)
-  Programming mode - running defined programs
-  Programmed status
-  Eco - set point selected
-  Setup -when in dual mode
-  Calling/Demand
-  Timed ON/OFF functionality
-  Holiday mode selected
-  Low battery  
Solid - 10%    Flashing - 1%
-  Timed mode - ON/OFF function only
-  External sensor temperature

# ICON OVERVIEW

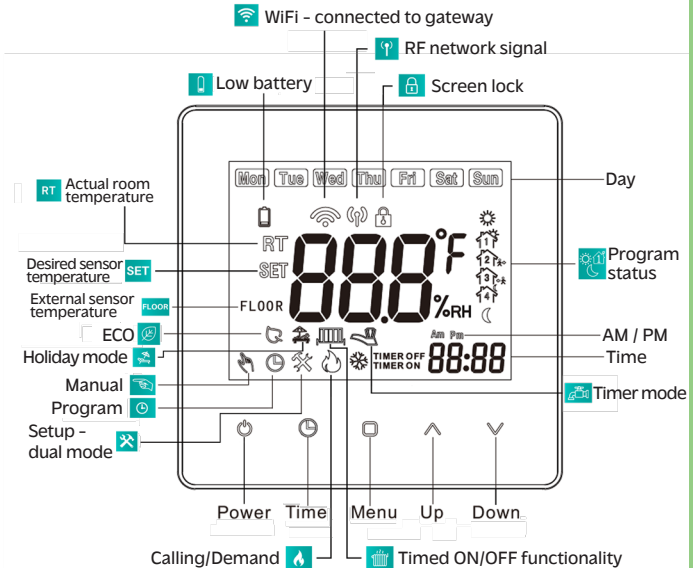





## CONFIGURATION MENU

No.	Function	Setting Options	Default
1	Operating mode	<b>1.</b> Thermostat <b>2.</b> Timer <b>3.</b> Thermostat & timer	1
2	System type	<b>rA:</b> Radiators <b>UF:</b> Underfloor	UF
3	Temperature calibration	-9°C to 9°C	0
4	Dead band	1°C to 5°C	1
5	Lock screen	<b>0:</b> All lock excluding power button. <b>1:</b> All lock	0
6	Sensor select	<b>In:</b> Internal <b>Ext:</b> External <b>All:</b> Dual	In
7	Max. settable temperature	20°C to 45°C	35°C
8	Min. settable temperature	5°C to 20°C	5°C
9	Over temperature cut off	20°C to 70°C	45°C
10	Anti-frost temperature	2°C to 10°C	5°C
11	Display mode	<b>0:</b> Room & set temperature <b>1:</b> Set temperature only	0
12	Anti-freeze	<b>0:</b> OFF <b>1:</b> ON	1
13	Frost protection	<b>0:</b> OFF <b>1:</b> ON	0
14	Frost protection temperature set	5°C to 30°C	16°C

## FACTORY DEFAULT PROGRAMS

Please familiarise yourself with the thermostats pre-programmed factory settings.

Period Display	Description	Time	Set Temp. °C
	Morning	06:00	22
	Leaving home	08:00	16
	Returning home	18:00	22
	Bedtime/ Overnight	22:00	16

# SELECTING YOUR OPERATING MODE

The desired functionality of the thermostat can be one of three options:  
**(Function must be selected before pairing with wiring centre)**

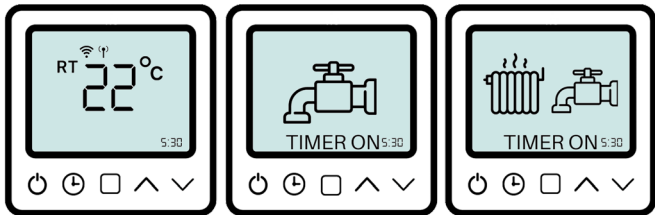

1







**THERMOSTAT  
MODE**

2

**TIMER MODE**

3

**THERMOSTAT  
& TIMER MODE**

1. Turn the thermostat off by pressing .
2. Press and hold  for 7 seconds to enter the configuration menu. Operating mode is configuration 1.
3. Use   to cycle to the required configuration.
4. Then select between mode **1**, **2**, **3** using  .
5. Press  to confirm your selection.

# THERMOSTAT MODE UFH or Radiator

The thermostat is factory set to operate in UFH programming mode.

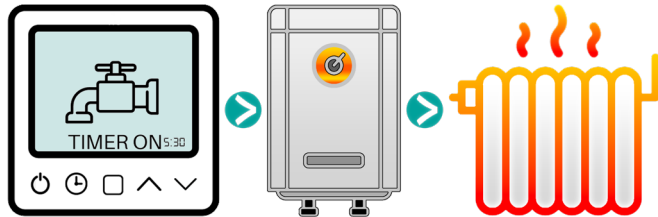

If you wish to operate the radiators only and bring the boiler live without the UFH Pump and Valve:

1. Put the operating mode into **2**.
2. Switch the system type into rA in configuration 2.



# THERMOSTAT MODE

## Manual Mode

1. To operate the thermostat as a simple up and down easy to use mode; tap  until the hand symbol appears .

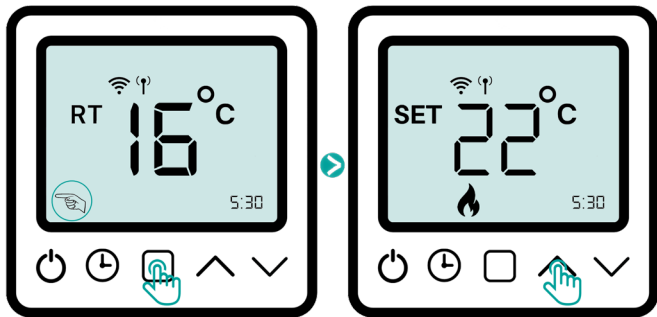

2. Using   you can now set your designed temperature.

3. The thermostat will activate when the desired temperature is set higher than the room temperature. This is signified by the flame symbol .

# THERMOSTAT MODE



## Programming Mode

When in programming mode, the screen will display the clock symbol in the bottom left hand corner.

To enter programming options:

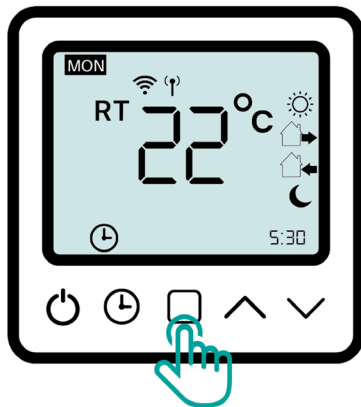
1. Press and hold  for 5 seconds.



2. Once in programming mode, press  to sequence through each time period and using   to set your desired preferences;

Day	MON
Time	5:30
Temperature	22°C
Period	



## TIMER OPERATION

**Program mode:** This setting will allow you to set up to 4 time periods, in which your heating demands will adjust.

**Hold mode:** This setting allows you to set a timer duration for your hot water requirements. You can set a duration of up to 99 hours and 59 minutes.

When the thermostat is in timer operation, the timer function symbol will display on the screen .



1. To set the function, press  and use   to select one of AUTO, HOLD or OFF options as required.





2. Press  to confirm your selection.

## TIMER OPERATION

**Program mode:**  
When you select AUTO (programmable) mode press and hold  to enter program settings.



The order is Monday-Friday >  
Period 1 > Time ON > Time OFF >  
Period 2 > Time ON > Time OFF >  
Period 3 > Time ON > Time OFF >  
Period 4 > Time ON > Time OFF.







**Hold mode:**  
Tap  to select HOLD.  
Using   adjust your timer setting.  
Tap  to confirm your setting.







## THERMOSTAT & HOT WATER TIMER OPERATION







When in this operation mode, the LCD will display   at the same time.

1. Short press  and use   to select the thermostat and hot water timer functions.
2. Press  to confirm.

Thermostat Timer:





1. Short press  to enter  thermostat function.
2. Then press   to select manual or program mode.
3. Press  to confirm.

Hot Water Timer:

1. Short press  to select  H/W timer.
2. Use   to select AUTO (auto programmable), HOL (hold) or OFF.
3. When HOLD is selected, you can adjust the time setting range: 00:01-99:59 using   and pressing  to confirm.





## THERMOSTAT & HOT WATER TIMER OPERATION

Program mode:

1. Long press  for 7 seconds to select  thermostat function and  H/W timer setting.
2. Short press  to confirm.

When in operation 3, after pairing the thermostat with the wiring centre on channels 1-8, the H/W will also automatically pair.

## HOLIDAY MODE

1. With the thermostat on, long press  for 7 seconds to enter holiday mode.
2. Short press   button to set the day and temperature parameters you need.
3. Press  to exit this. During holiday mode, H/W timer is OFF.
4. To exit holiday mode, short press .

# SENSOR COMPATIBILITY

The TEVO thermostat can be connected with an external sensor.

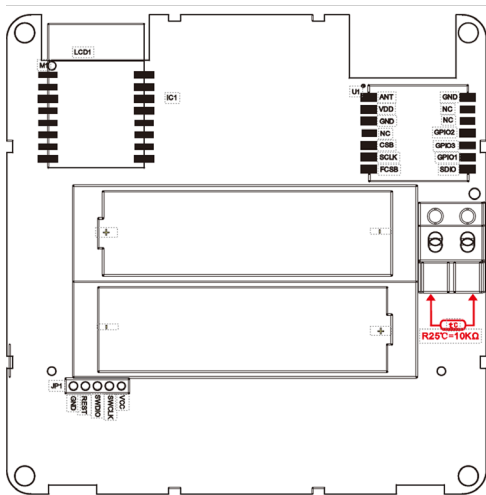



# WIRELESS WIRING CENTRE

## RF Pairing



Only compatible with the TEVO series thermostats, the wireless wiring centre is a central control point for multi-purpose systems.

Pairing your wiring centre:

1. Power ON your wiring centre.
2. Press and hold switch 2 until a red LED appears.
3. Navigate to the zone you would like to pair your thermostat with using the same switch.
4. Power OFF your thermostat and press both  and  buttons for 7 seconds.

# WIRELESS WIRING CENTRE

## RF Pairing

5. When the LCD displays “---” this means that the thermostat is in active pairing mode.

(Thermostat is searching for it's active pairing zone)

6. If you have successfully paired your devices, the LCD will display the zone that it has paired with. H/W is channel 9.

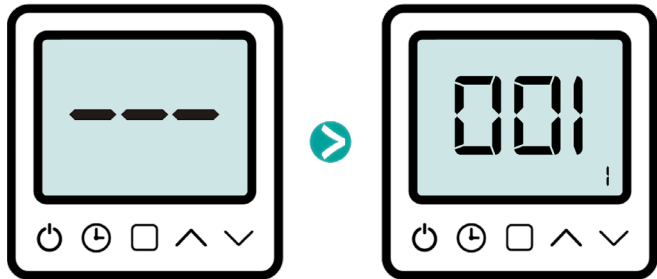

7. Your thermostats pairing code is the large number found in the center of the screen and zone number in the bottom right corner.

# WIRELESS GATEWAY



The wireless gateway will link the RF wiring centre to the TEVO thermostat through ZIGBEE protocols to enable app functionality.

Utilising the in-app features users the ability to make adjustments from anywhere at any time.

This unit is easy to install. Simply plug it in using the USB cable provided and follow the subsequent connection process.

# WIRELESS GATEWAY

## PAIRING IN-APP

In order to access our thermostats app functionality, you will need to download and install the Smart Life app. The QR code below will take you directly to the download page.



Once installed, please proceed by registering your very own account. Please follow the on-screen instructions to complete the process. If you already have a registered account, please continue to the next step. You may use the email password retrieval system if you have forgotten your password.

# WIRELESS GATEWAY

## PAIRING IN-APP

1. Power ON your wireless gateway.
2. Turn your devices' Bluetooth ON.
3. Long press  until the blue light is stable and the red light is flashing.
4. The app will now automatically find your device.

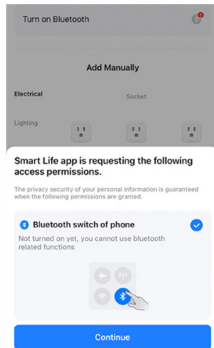

5. If the app was unable to find your device, please manually select "Wireless Gateway (Zigbee)" from the menu.

# WIRELESS GATEWAY PAIRING IN-APP

Follow the on-screen instructions to setup your device.

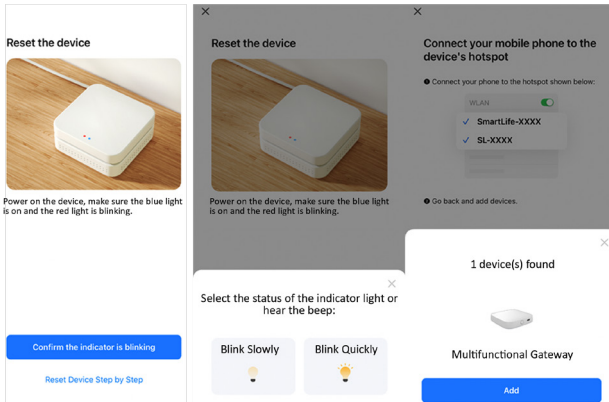

The key benefit of pairing to the Smart Life app through the gateway, is that your settings will be stored within the cloud and in the event of a power outage your desired setting will remain in place.

# WIRELESS GATEWAY PAIRING IN-APP

Select 2.4 GHz Wi-Fi network and enter the password.

If your Wi-Fi is 5GHz, please set it to be 2.4GHz  
[Common router setting method](#)

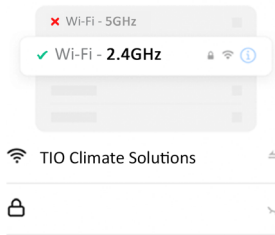

You will now be asked to connect your device to the desired Wi-Fi band.

Please note that after this step, you may be asked to complete a firmware update.

Please proceed in doing so, as your gateway will need to be fully updated to access all current features.



# TEVO THERMOSTAT PAIRING IN-APP

- To pair your thermostat with your wireless gateway:
1. Long press  over 7 seconds with the thermostat ON. The thermostat will display “---”.
  2. When on the gateway device screen on the Smart Life app, select Zigbee devices, press “Add devices” and select “Add new devices”.

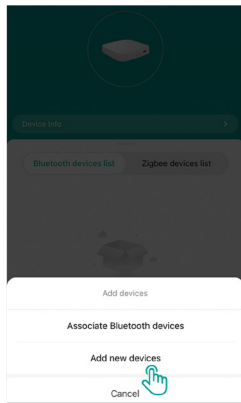
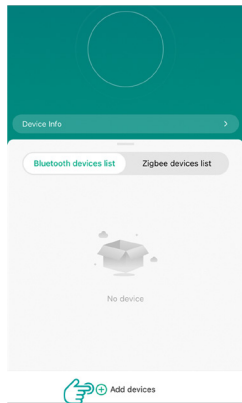

# TEVO THERMOSTAT PAIRING IN-APP

3. The app will discover nearby devices.
4. You will be asked to add the device to your profile.
5. Please name your device to the zone or room it is allocated to.
6. Then press “Finish”.

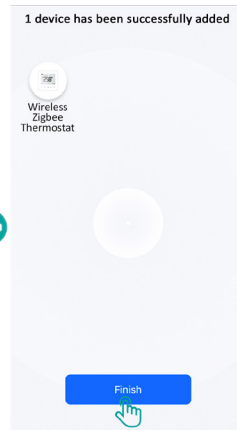
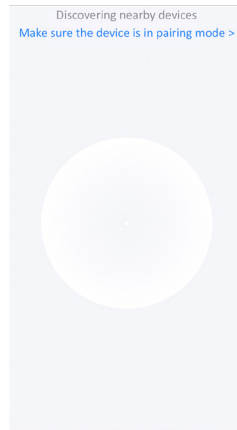

# APP CONFIGURATION

Once your thermostat has connected successfully, you can change the setting parameters as you require.

If there is no connection between the thermostat and wiring centre or the codes do not match; the screen will display “Please match code”. Once paired correctly, the message will disappear.

**Power:** ON/OFF

**Mode selection:** Manual/ECO/Program

**Child lock:** Lock/Unlock the thermostat

**Settings:** Temperature compensation adjustment, anti-freeze switch and factory reset switch.

**System:** Long press this button over 3 seconds. Selecting between Thermostat, H/W timer or Thermostat & H/W timer control.

**Holiday:** Alter day and temperature selection for when you go for a vacation.

**Program:** You can program your thermostats heating and timer functions for each day over 4 time periods.

# APP CONFIGURATION

Your TEVO thermostat has multi-function capabilities. There are altering menu interfaces for you to familiarise yourself with in order to maximise it's use.

## 1. Thermostat Function:

Here you can select your thermostats working hours and target temperature.

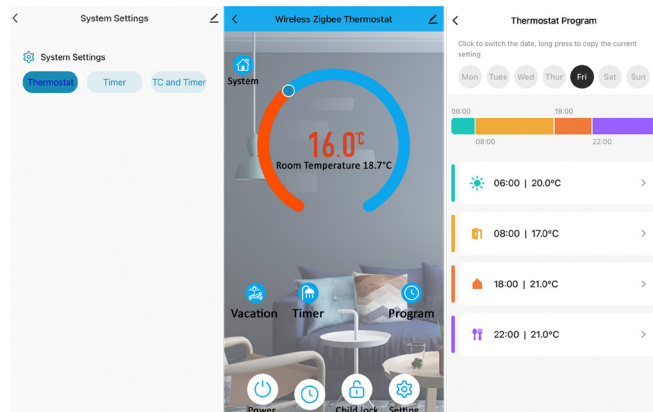

# APP CONFIGURATION

2. Timer Function:  
Here you can activate your thermostats timer functionality.

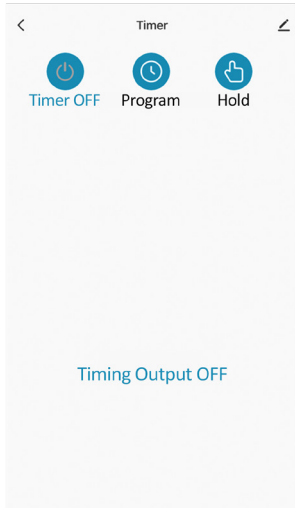
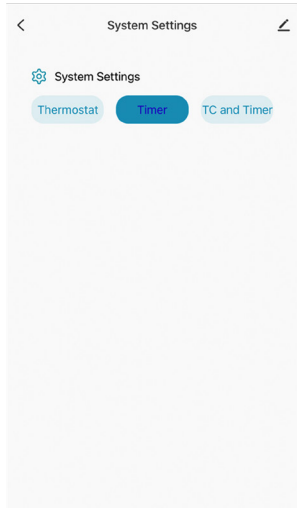

# APP CONFIGURATION

You can select your operating hours and the duration of heating on this menu screen.

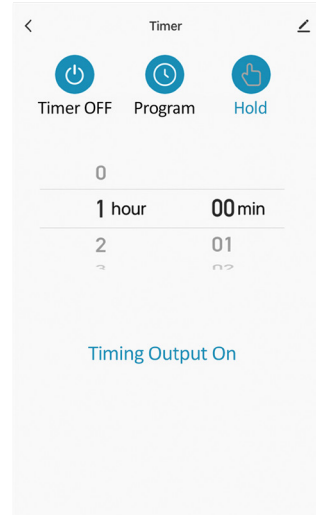
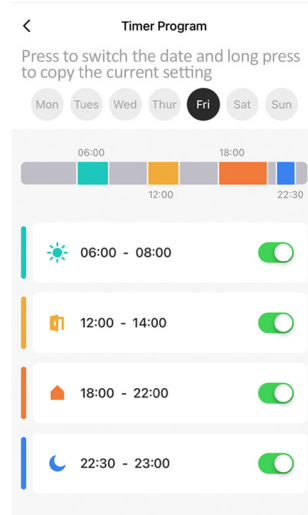



# APP CONFIGURATION

## 3. Thermostat & H/W Timer Function:

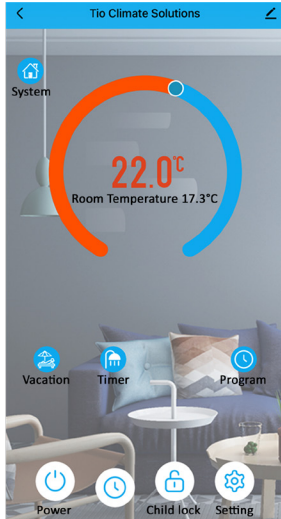
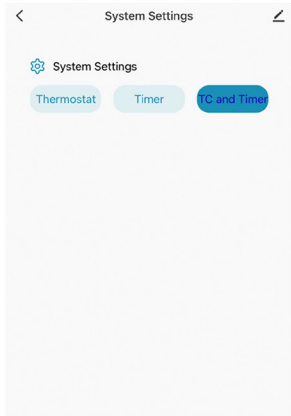
This setting utilises both the thermostat functionality and the timer capabilities of your thermostat. Managing both the target temperature and duration of heating.



# IMPORTANT NOTES

- 1  Thermostat setting order:  
Mon-Fri, Sat, Sun > Period 1 > Time ON > Time OFF (4 periods).
- 2  H/W setting order:  
Mon-Fri, Sat, Sun > Period 1 > Time ON > Time OFF (4 periods).
- 3 Radiators: When you use the radiators system, there is no pump utilisation.
- 4 Underfloor Heating: When you select the UFH system, there will be a pump output. Wiring centre will have a 3 minute delay.

# IMPORTANT NOTES

5 ❄️ Anti Freeze Function: When thermostat detects a room temperature of lower than or equal to 5°C, the thermostat will activate the heating. Once a room temperature of 8°C is detected, the heating will turn OFF.

6 🔋 Low battery alarm: Low battery icon will display when the battery is down to 10%. The icon will flash when the battery is down to 1%. At this stage you should replace with new batteries immediately, as the thermostat will stop functioning.

7 🚫 Error code: When the thermostat sensor is broken or has a problem, the LCD will display "ERR".

8 📶 Wireless gateway is needed for app control functionality.

# VOICE CONTROL

Select ↗️ icon to access the settings menu. You can now access both Alexa and Google Assistant under the "Third-Party Control" tab. Please note that the compatibility and connection between the Smart Life app and third-party voice control platforms is facilitated via Smart Life and not Tio Climate Solutions Ltd.

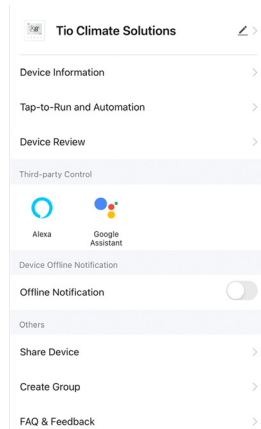
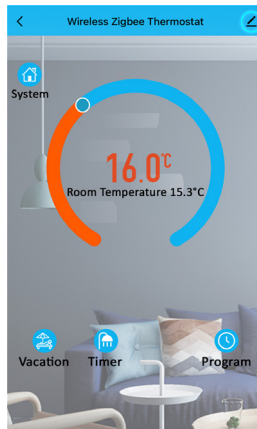

tio

[www.tioclimatesolutions.co.uk](http://www.tioclimatesolutions.co.uk)

